

FEATURES

- * Current transfer ratio
(CTR : MIN. 50% at $I_F = 5\text{mA}$, $V_{CE} = 5\text{V}$)
- * High input-output isolation voltage
($V_{iso} = 5,000\text{Vrms}$)
- * Response time
(t_r : TYP. $4\mu\text{s}$ at $V_{CE} = 2\text{V}$, $I_C = 2\text{mA}$, $R_L = 100\Omega$)
- * Dual-in-line package :
 - LTV-817 : 1-channel type
 - LTV-827 : 2-channel type
 - LTV-847 : 4-channel type
- * Wide lead spacing package :
 - LTV-817M : 1-channel type
 - LTV-827M : 2-channel type
 - LTV-847M : 4-channel type
- * Surface mounting package :
 - LTV-817S : 1-channel type
 - LTV-827S : 2-channel type
 - LTV-847S : 4-channel type
- * Tape and reel packaging :
 - LTV-817S-TA1, LTV-827S-TA1
- * UL approved (No. E113898)
- * TUV approved (No. R9653630)
- * CSA approved (No. CA91533-1)
- * FIMKO approved (No. 202634)
- * NEMKO approved (No. P98101945)
- * DEMKO approved (No. 307857)
- * SEMKO approved (No. 0109172 / 01-03)
- * VDE approved (No. 094722)
- * BSI approved (No. 8701)
- * Critical characteristic
- * Safety or compliance characteristic.

OUTLINE DIMENSIONS

LTV-817 :

TYPE I (INK MARK)

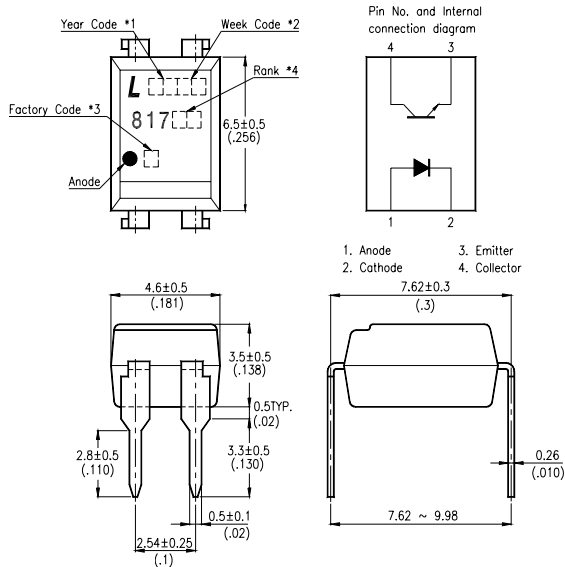

TYPE II (LASER MARK)

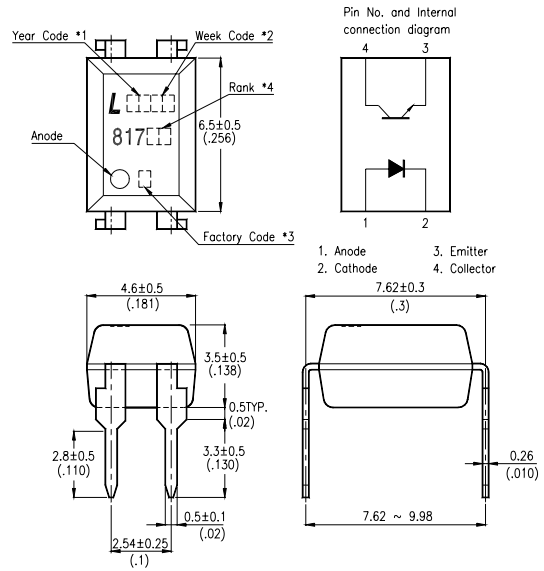

LTV-827 :

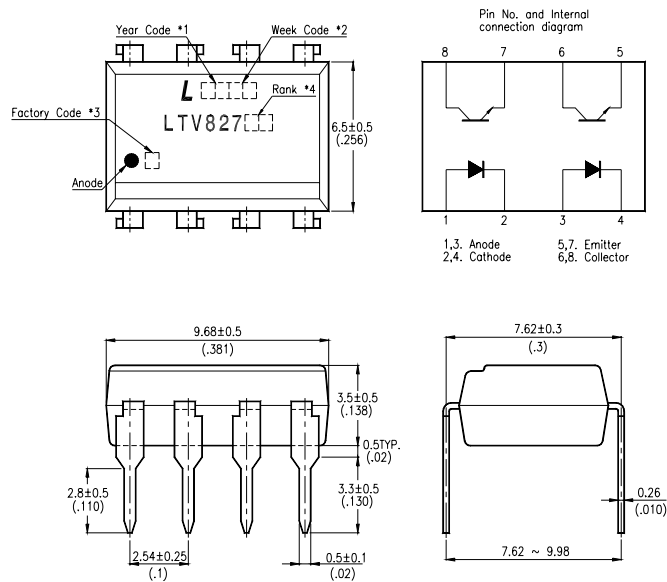

- *1. Year date code.
- *2. 2-digit work week.
- *3. Factory identification mark shall be marked (Z : Taiwan, Y : Thailand, X : China).
- *4. Rank shall be or shall not be marked.

OUTLINE DIMENSIONS

LTV-847 :

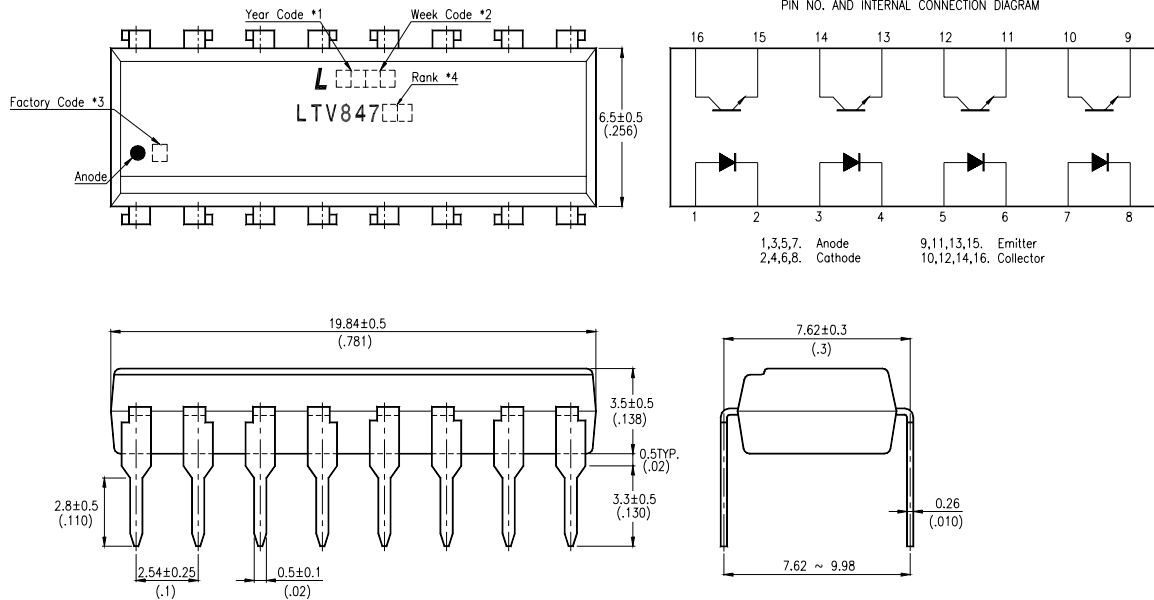

LTV-817M :

TYPE I (INK MARK)

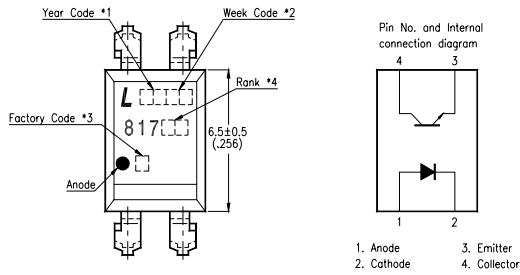

TYPE II (LASER MARK)

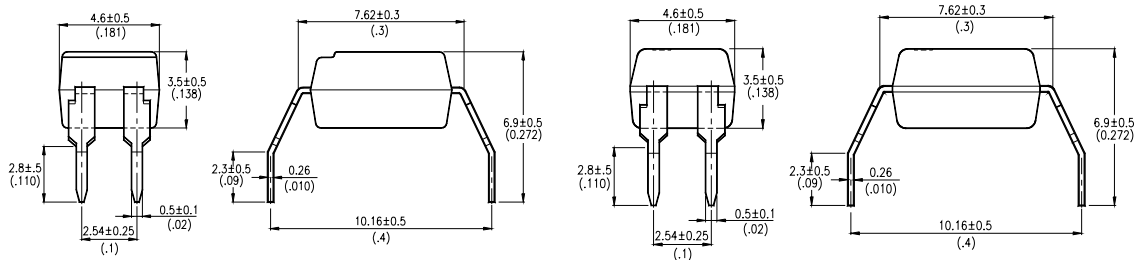
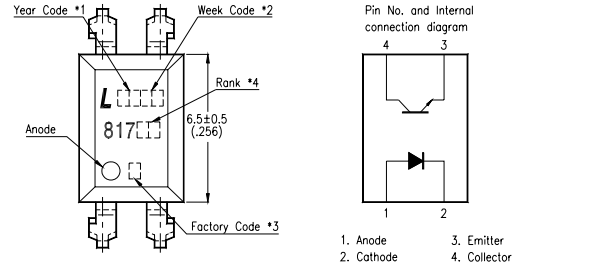

- *1. Year date code.
- *2. 2-digit work week.
- *3. Factory identification mark shall be marked (Z : Taiwan, Y : Thailand, X : China).
- *4. Rank shall be or shall not be marked.

OUTLINE DIMENSIONS

LTV-827M :

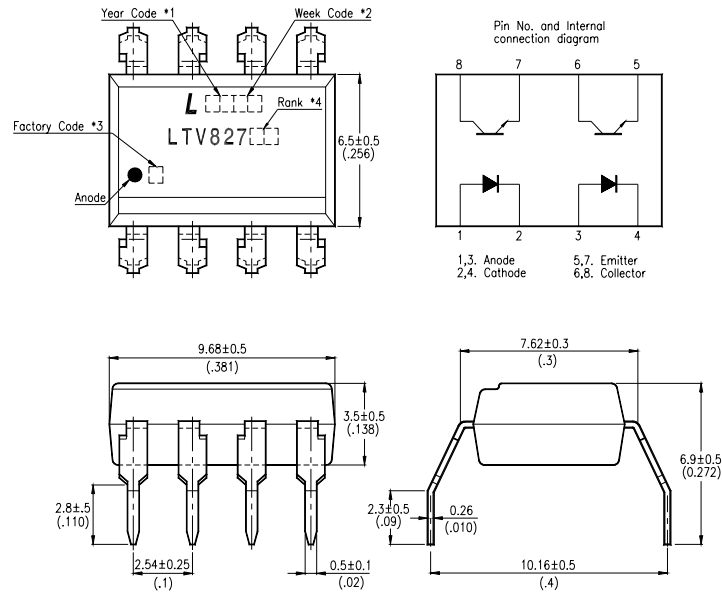

LTV-847M :

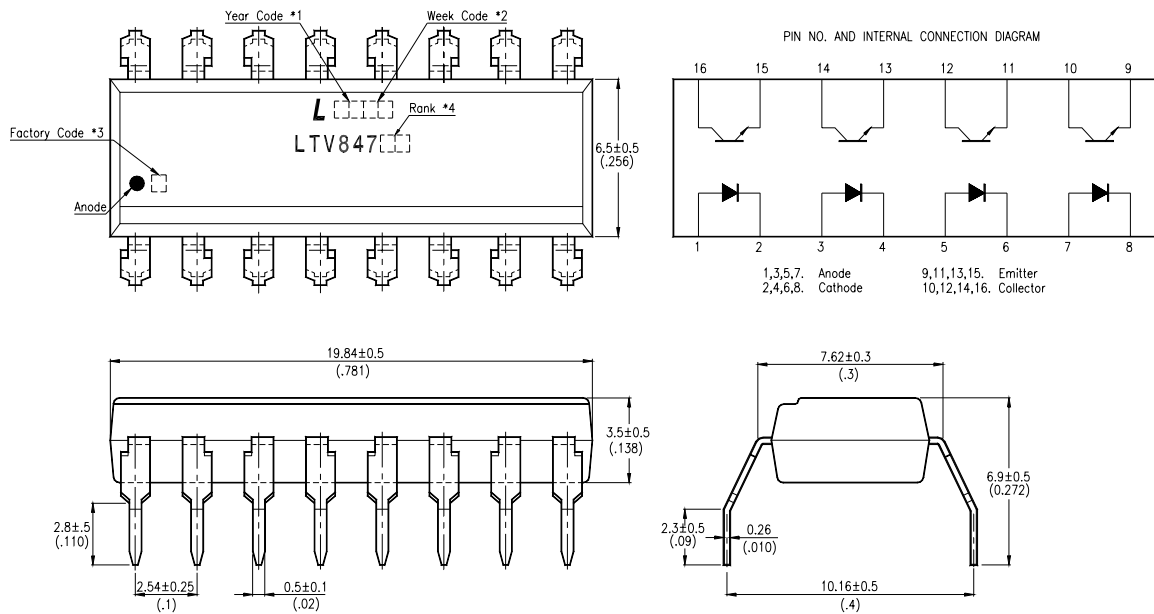

- *1. Year date code.
- *2. 2-digit work week.
- *3. Factory identification mark shall be marked (Z : Taiwan, Y : Thailand, X : China).
- *4. Rank shall be or shall not be marked.

OUTLINE DIMENSIONS

LTV-817S :

TYPE I (INK MARK)

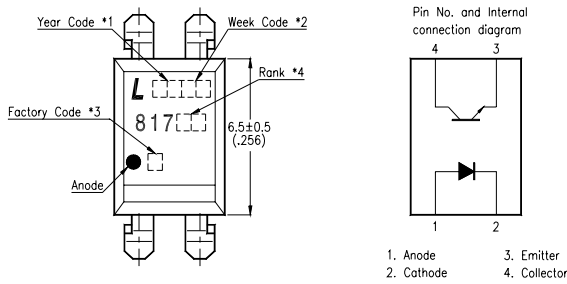

TYPE II (LASER MARK)

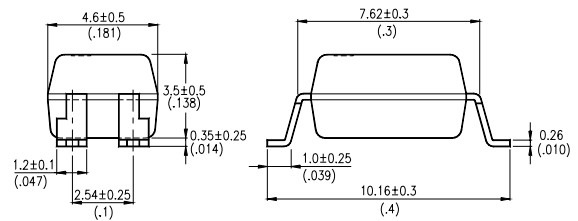
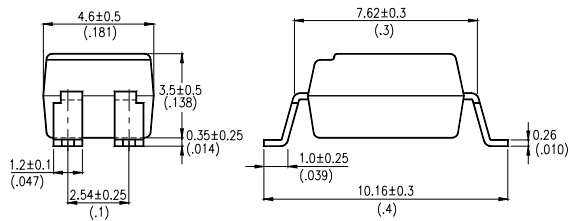
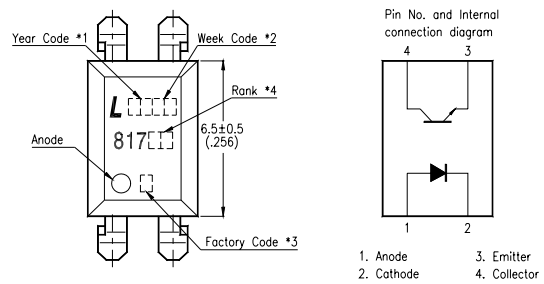

LTV-827S :

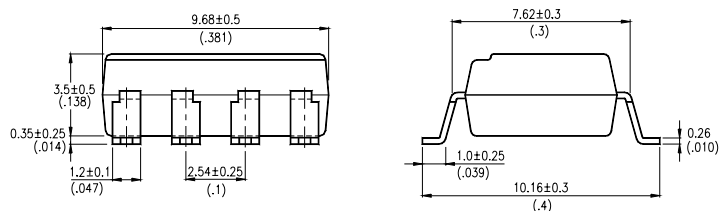
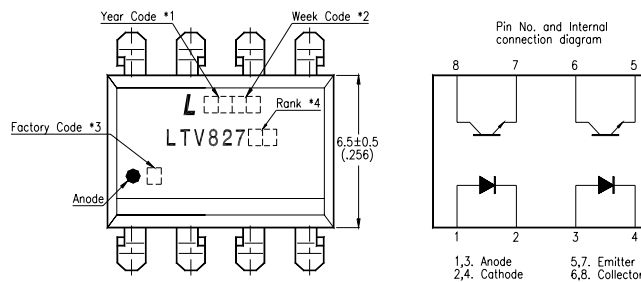

- *1. Year date code.
- *2. 2-digit work week.
- *3. Factory identification mark shall be marked (Z : Taiwan, Y : Thailand, X : China).
- *4. Rank shall be or shall not be marked.

OUTLINE DIMENSIONS

LTV-847S :

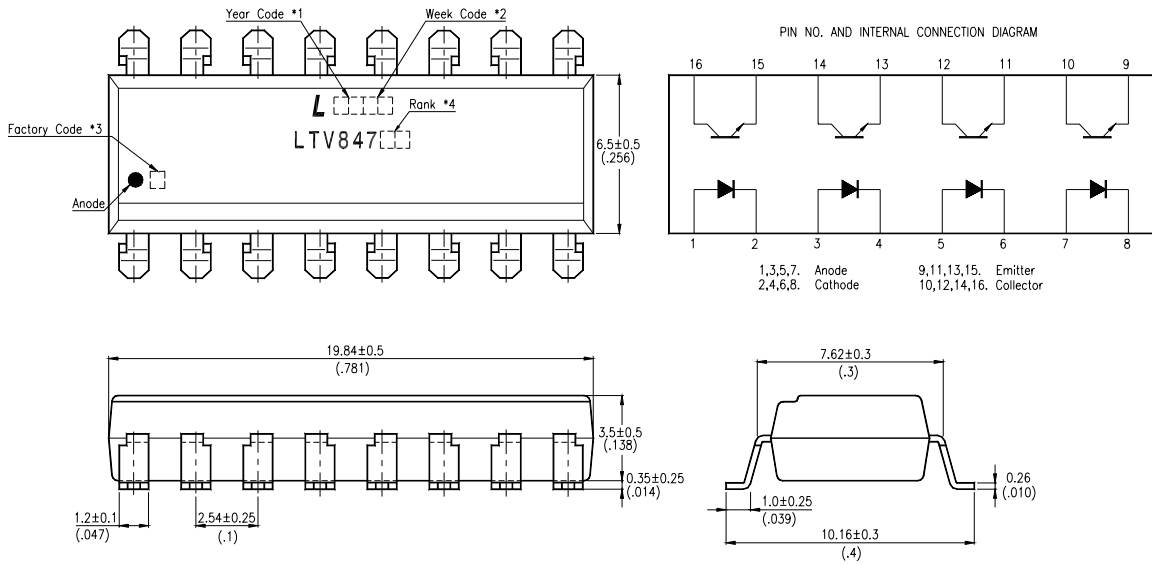

- *1. Year date code.
- *2. 2-digit work week.
- *3. Factory identification mark shall be marked (Z : Taiwan, Y : Thailand, X : China).
- *4. Rank shall be or shall not be marked.

TAPING DIMENSIONS

LTV-817S-TA1 :

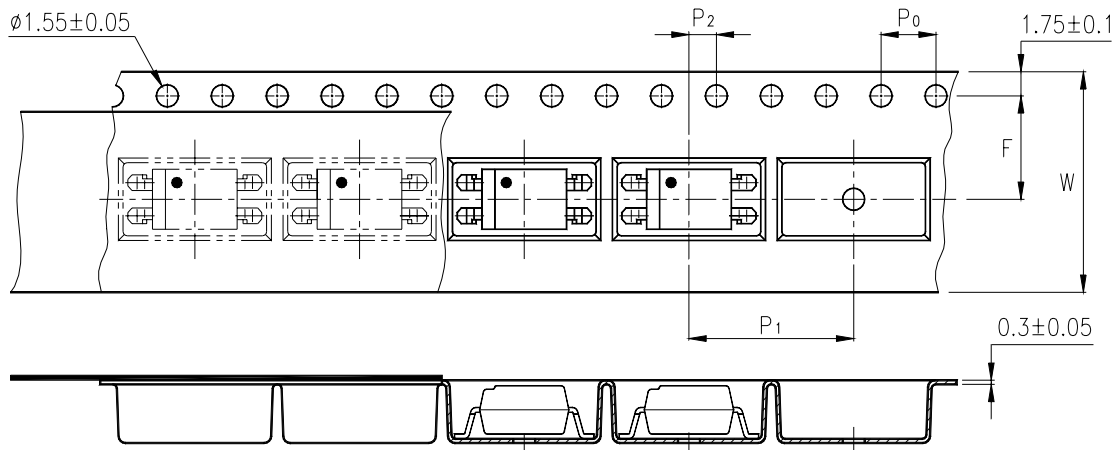

LTV-827S-TA1 :

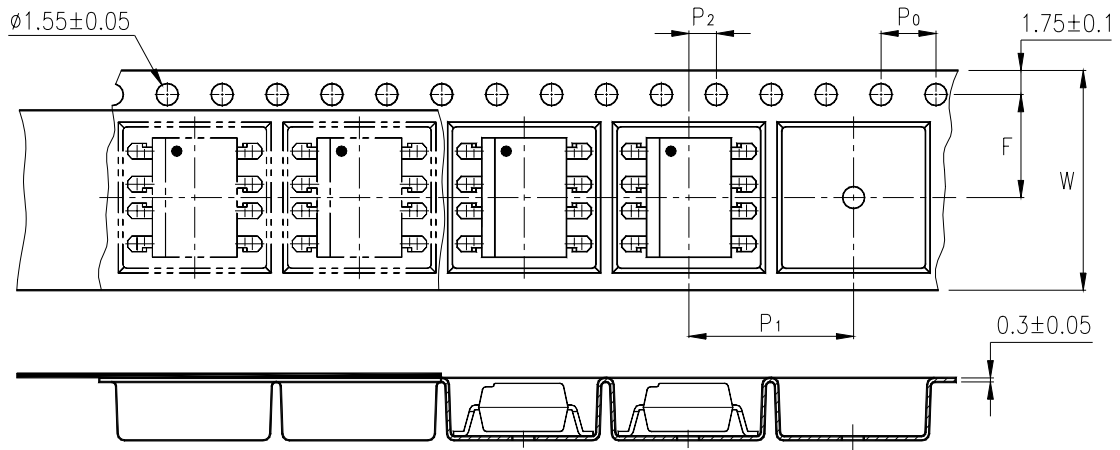

Description	Symbol	Dimensions in mm (inches)
Tape wide	W	16 ± 0.3 (.63)
Pitch of sprocket holes	P_0	4 ± 0.1 (.15)
Distance of compartment	F	7.5 ± 0.1 (.295)
Distance of compartment to compartment	P_1	12 ± 0.1 (.472)
	P_2	2 ± 0.1 (.079)

ABSOLUTE MAXIMUM RATING

(Ta = 25°C)

PARAMETER		SYMBOL	RATING	UNIT
INPUT	Forward Current	I _F	50	mA
	Reverse Voltage	V _R	6	V
	Power Dissipation	P	70	mW
OUTPUT	Collector - Emitter Voltage	V _{CEO}	35	V
	Emitter - Collector Voltage	V _{ECO}	6	V
	Collector Current	I _C	50	mA
	Collector Power Dissipation	P _C	150	mW
Total Power Dissipation		P _{tot}	200	mW
*1	Isolation Voltage	V _{iso}	5,000	V _{rms}
Operating Temperature		T _{opr}	-30 ~ +100	°C
Storage Temperature		T _{stg}	-55 ~ +125	°C
*2	Soldering Temperature	T _{sol}	260	°C

*1. AC For 1 Minute, R.H. = 40 ~ 60%

Isolation voltage shall be measured using the following method.

- (1) Short between anode and cathode on the primary side and between collector and emitter on the secondary side.
- (2) The isolation voltage tester with zero-cross circuit shall be used.
- (3) The waveform of applied voltage shall be a sine wave.

*2. For 10 Seconds

ELECTRICAL - OPTICAL CHARACTERISTICS

(Ta = 25°C)

PARAMETER		SYMBOL	MIN.	TYP.	MAX.	UNIT	CONDITIONS
INPUT	Forward Voltage	V _F	—	1.2	1.4	V	I _F =20mA
	Reverse Current	I _R	—	—	10	μA	V _R =4V
	Terminal Capacitance	C _t	—	30	250	pF	V=0, f=1KHz
OUTPUT	Collector Dark Current	I _{CEO}	—	—	100	nA	V _{CE} =20V, I _F =0
	Collector-Emitter Breakdown Voltage	BV _{CEO}	35	—	—	V	I _C =0.1mA I _F =0
	Emitter-Collector Breakdown Voltage	BV _{ECO}	6	—	—	V	I _E =10μA I _F =0
TRANSFER CHARACTERISTICS	Collector Current	I _C	2.5	—	30	mA	I _F =5mA
	*1 Current Transfer Ratio	CTR	50	—	600	%	V _{CE} =5V
	Collector-Emitter Saturation Voltage	V _{CE(sat)}	—	0.1	0.2	V	I _F =20mA I _C =1mA
	Isolation Resistance	R _{iso}	5×10 ¹⁰	1×10 ¹¹	—	Ω	DC500V 40 ~ 60% R.H.
	Floating Capacitance	C _f	—	0.6	1	pF	V=0, f=1MHz
	Cut-Off Frequency	f _c	—	80	—	kHz	V _{CE} =5V, I _C =2mA R _L =100Ω, -3dB
	Response Time (Rise)	t _r	—	4	18	μs	V _{CE} =2V, I _C =2mA R _L =100Ω
	Response Time (Fall)	t _f	—	3	18	μs	

$$*1 \text{ CTR} = \frac{I_C}{I_F} \times 100\%$$

RANK TABLE OF CURRENT TRANSFER RATIO CTR

MODEL NO.	RANK MARK	CTR (%)
LTV-817	L	50 ~ 100
	A	80 ~ 160
	B	130 ~ 260
	C	200 ~ 400
	D	300 ~ 600
	L or A or B or C or D	50 ~ 600
LTV-827 LTV-847	B	130 ~ 260
	B or C or BC	130 ~ 400
	C	200 ~ 400
	C or D or CD	200 ~ 600
	B、 BC、 C、 CD or No mark	50 ~ 600

CONDITIONS	$I_F = 5 \text{ mA}$ $V_{CE} = 5 \text{ V}$ $T_a = 25 \text{ }^\circ\text{C}$
-------------------	---

CHARACTERISTICS CURVES

Fig.1 Forward Current vs. Ambient Temperature

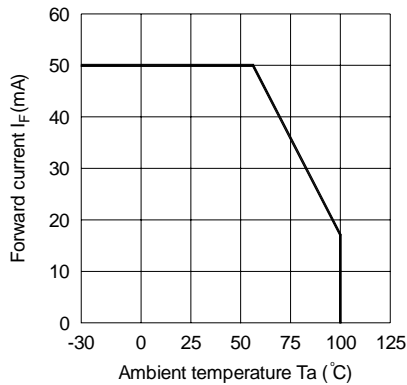

Fig.2 Collector Power Dissipation vs. Ambient Temperature

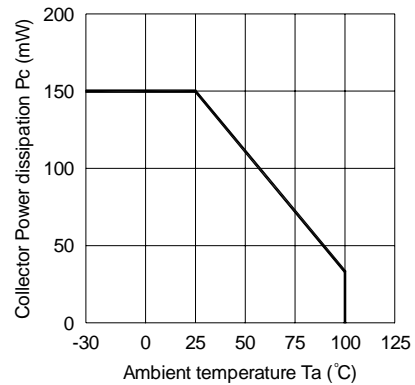

Fig.3 Collector-emitter Saturation Voltage vs. Forward Current

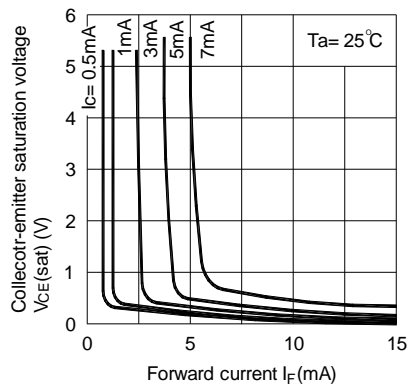

Fig.4 Forward Current vs. Forward Voltage

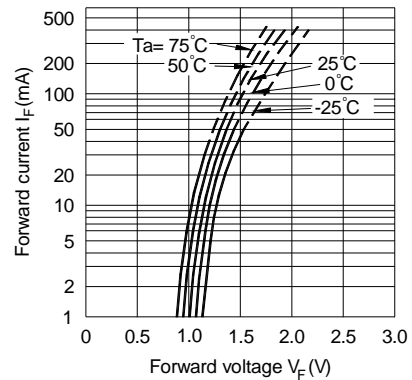

Fig.5 Current Transfer Ratio vs. Forward Current

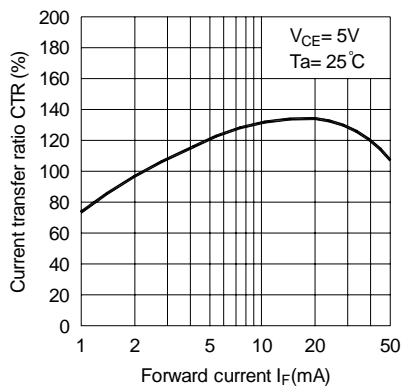
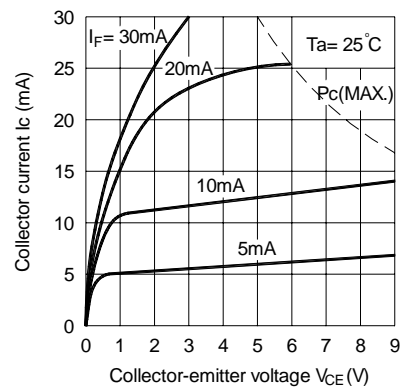

Fig.6 Collector Current vs. Collector-emitter Voltage



CHARACTERISTICS CURVES

Fig.7 Relative Current Transfer Ratio vs. Ambient Temperature

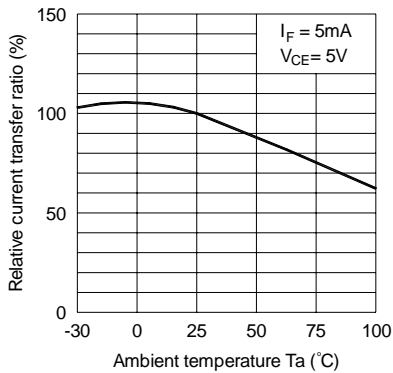

Fig.8 Collector-emitter Saturation Voltage vs. Ambient Temperature

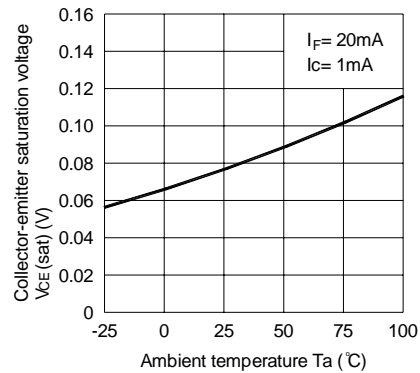

Fig.9 Collector Dark Current vs. Ambient Temperature

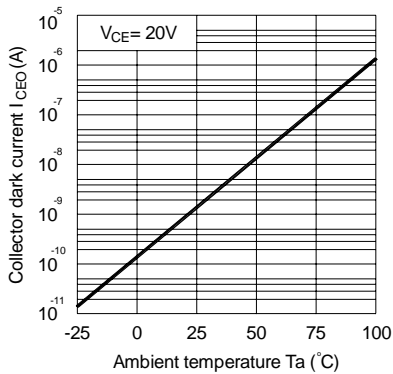

Fig.10 Response Time vs. Load Resistance

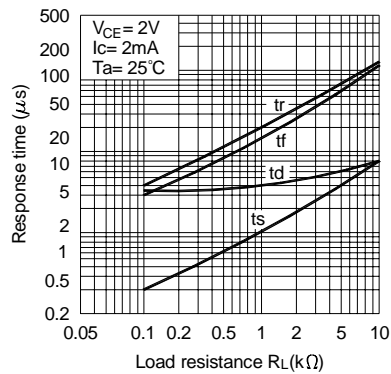
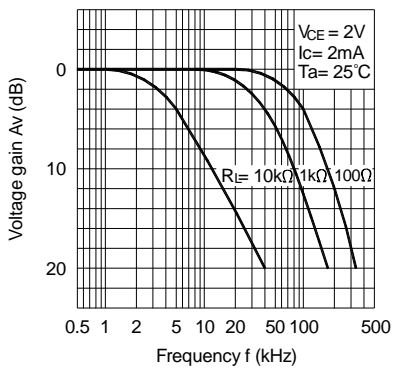
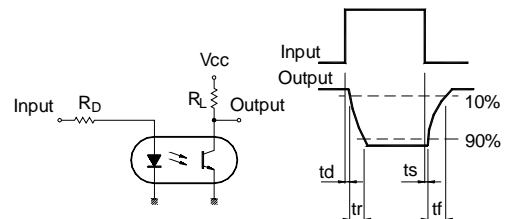

Fig.11 Frequency Response



Test Circuit for Response Time



Test Circuit for Frequency Response

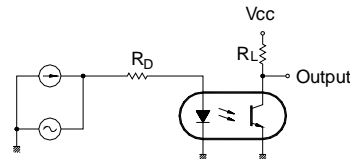

RECOMMENDED FOOT PRINT PATTERNS (MOUNT PAD)

Unit : mm

4 PIN

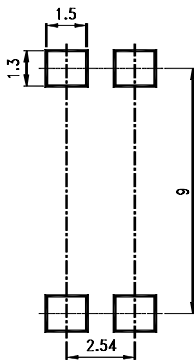

8 PIN

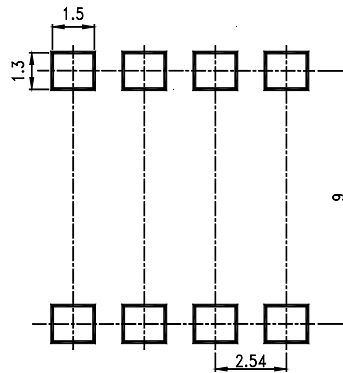

16 PIN

